

VTT-1000

Vehicle Tracking Terminal

- 3.5" TFT LCD touch screen
- Embedded with ARM9 400MHz CPU
- Pre-installed Windows® CE 6.0
- Built-in GSM/GPRS and antenna
- SiRF Star III 20-channel GPS receiver
- Supports On-Board Diagnostics (OBD)



Applications

- Fleet Management System
- In-Vehicle Infotainment
- Location-Based Services
- Real-time Vehicle Diagnostic
- Emergency and Security Services



Compact, Rugged, High Performance, and Low Power Consumption

ARM926EJ core with built-in 2D graphics accelerator

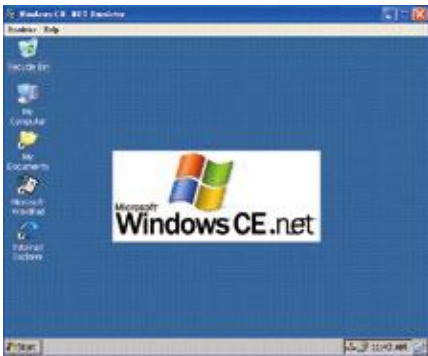
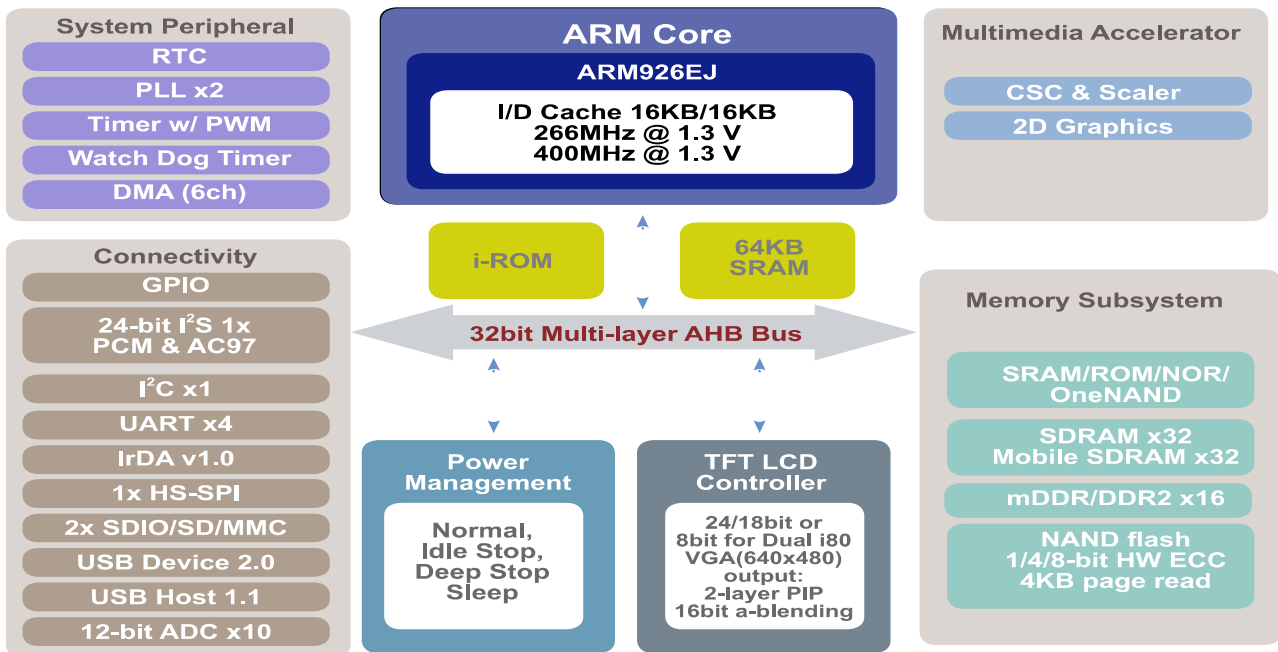

- Pre-installed Windows® CE 6.0 R3
- Waterproof Front Panel LCD Display
- IP54 Compliant Dustproof Housing
- 20°C ~ 70°C Wide Operating Temperature
- Shock and Vibration Protection in Vehicle Environment

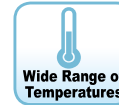

Global Positioning System (GPS) Receiver

Specifications	
Chipset	SiRF Star III, GSC3f/LPx (Digital, RF in a single package)
Frequency	L1, 1575.42 MHz
Channels	20 parallel
C/A Code	1023 MHz
Chipset TTFF	Reacquisition: Less than 1s Hot start: Less than 1s @ open sky Warm start: Less than 35s @ open sky Cold start: Less than 35s @ open sky
Accuracy	Position: Within 10m for 90% Velocity: 0.1m/s
Interface Protocol	1. NMEA 0183 ver 3.0, GGA, GSA, GSV, RMC, 4800bps 2. SiRF Protocol 57600bps, 8 data bits, no parity, 1 stop bits
LNA	15dB Gain.(Typ.) LNA only enable by LPX series
Internal Memory	Flash type on 4MB
TCXO	16.369 MHz
Trickle Power Mode	Duty cycle ≤ 34%. (Variable) Default: Disable (Option: Enable)



GSM/GPRS Telecommunication

VTT-1000 is equipped with a Cinterion (formerly Siemens) MC55i wireless module and built-in antenna for machine-to-machine (M2M) communication over GPRS. The MC55i is awarded full type approval and certified by global carriers and operators. It is optimized with quad-band technology for worldwide roaming.

- Quad-Band GSM 850/900/1800/1900 MHz
- GPRS multi-slot class 10
- GSM phase 2/2+ compliant
- TCP/IP stack access via AT commands
- Internet Services: TCP, UDP, HTTP, FTP, SMTP, POP3
- Control via AT commands
(Hayes 3GPP TS 27.007, TS 27.005)
- SIM Application Toolkit
- Specification for GPRS data transmission:
 - GPRS class 10: max. 86 kbps (DL)
 - Mobile station class B
 - PBCCH support
 - Coding schemes CS 1-4



In-Vehicle Communication

• Almost all of the automobiles produced today are required by law to provide an interface for connecting the diagnostic test equipment. The VTT-1000 provides a connection to vehicle On-Board Diagnostics (OBD) port (OBD-II connector) and supports the most common data transfer protocols and standards in use today.



Protocols and Standards

SAE J1850 PWM (41.6 kbaud)
SAE J1850 VPW (10.4 kbaud)
ISO 9141-2 (5 baud init)
ISO 14230-4 KWP (5 baud init)
ISO 14230-4 KWP (fast init)
ISO 15765-4 CAN (11-bit ID, 500 kbaud)
ISO 15765-4 CAN (29-bit ID, 500 kbaud)
ISO 15765-4 CAN (11-bit ID, 250 kbaud)
ISO 15765-4 CAN (29-bit ID, 250 kbaud)
SAE J1939 CAN (29-bit ID, 250* kbaud)



OBD-II Connector



VTT-1000 connector

Supported OBD-II Connector Pins





OBD-II Pin	Description
1	-
2	Bus positive line of SAE-J1850 PWM and SAE-1850 VPW
3	-
4	-
5	-
6	CAN high (ISO 15765-4 and SAE-J2284)
7	K line of ISO 9141-2 and ISO 14230-4
8	-
9	-
10	Bus negative line of SAE-J1850 PWM only (not SAE-1850 VPW)
11	-
12	-
13	-
14	CAN low (ISO 15765-4 and SAE-J2284)
15	Line of ISO 9141-2 and ISO 14230-4
16	-

• In addition to traditional applications for diagnostic trouble code readers and automotive scan tools, emerging applications such as Location-based Services (LBS) and Fleet Management System (FMS) have started to combine OBD with GPS and telecommunication technology, making remote real-time diagnostics available.

Built-in Sensors and I/O

VTT-1000 includes built-in temperature sensor, G-sensor, E-compass, and digital I/O to provide advanced vehicle monitoring and control applications. For example:



- 
 - Alarm, light and sound supplier which automatically checks for unusual tags.
- 
 - An automatic emergency call will be initiated when airbag deployment is detected.
- 
 - When the G-Sensor detects a sudden brake or acceleration, system begins to log critical vehicle data, navigation data, and real-time picture or video.
- 
 - Real-time navigation and position logging.

Software Development Kits (SDK) and Built-in Software

In addition to Windows CE SDK, the VTT-1000 SDK contains easy to use API's for application software development

- Detect function key status (F1 ~ F4, and Menu1 ~ Menu3) and to program user interface applications
- Digital I/O offers an easy to use 4-bit digital I/O (2 inputs/2 outputs) configuration. Allows you to set digital outputs and read digital inputs
- Read temperature sensor data to monitor vehicle ambient temperature
- Read G-sensor data to monitor vehicle status
- Read E-compass data to log or display directions
- Open OBD-II port and read OBD-II PIDs (P-codes)

OBD-II PIDs are defined by SAE J1979. The expected response for each PID is given along with information on how to translate the response into meaningful data. Information includes:

- | | |
|--|---------------------------------------|
| •Vehicle speed | •DTC (Diagnostic Trouble Code) |
| •Engine RPM | •Calculated engine load |
| •Total fuel used (litre since life time) | •Intake air temperature |
| •High resolution vehicle distance | •Throttle position |
| •Engine coolant temperature | •Accelerator pedal position (0-100 %) |
| •Vehicle ambient temperature | •Axle weight (kg) |
| •Tachograph information | •Oxygen sensors and status |
| •Total engine hours (h) | •Clutch switch (on/off) |
| •Fuel level (0-100 %) | •Brake switch (on/off) |
| •Fuel pressure | •Cruise control (on/off) |
| •Fuel system status | •PTO (Status/Mode) |



The VTT-1000 SDK also provides free fleet management demo software, IEI FMS. This software is based on client/server architecture. Server-side software is contained in the bundled CD and can be installed in a Windows® desktop PC. Client-side software (VTT-1000 Runtime) is pre-installed in each VTT-1000. IEI FMS demonstrates the most basic function of fleet management software with the ability to gather, store, process, monitor, report on and export information.



Server-side Screen Shot

Client-side Screen Shot



OEM Built-in Optional 3rd Party Navigation Software (May Require MOQ and NRE Depending On Project Base)

Tailoring to your specific needs, VTT-1000 supports a diverse array of popular Navigation softwares currently on the market, such as Lingtu for China.



Lingtu With map of China

VTT-1000 WiFi **New**

Vehicle Tracking Terminal

- 3.5" TFT LCD touch screen
- Embedded with ARM9 400MHz CPU
- Pre-installed Windows® CE 6.0
- Built-in GSM/GPRS and Wi-Fi
- SiRF Star III 20-channel GPS receiver
- Supports On-Board Diagnostics (OBD)



Flexible Applications

The VTT-1000-wifi serves as a vehicle terminal that provides users with highly expandable options, allowing for a wide range of fleet management applications. It features a built-in Wi-Fi antenna that can access wireless network in surroundings. Vehicles with built-in wireless modems can greatly benefit from the VTT-1000-wifi. For example, information obtained from On-Board Diagnostics (OBD) can be transferred via Wi-Fi to the vehicle's built-in wireless modem and further sent to the back office management system.

- Fleet Management System
- In-Vehicle Infotainment
- Location-Based Services
- On-Board Diagnostics (OBD)
- Emergency and Security Services



VTT-1000 WiFi

IEMobile Introduction
Tablet PC
Industrial PDA (EDA)
Automotive PC

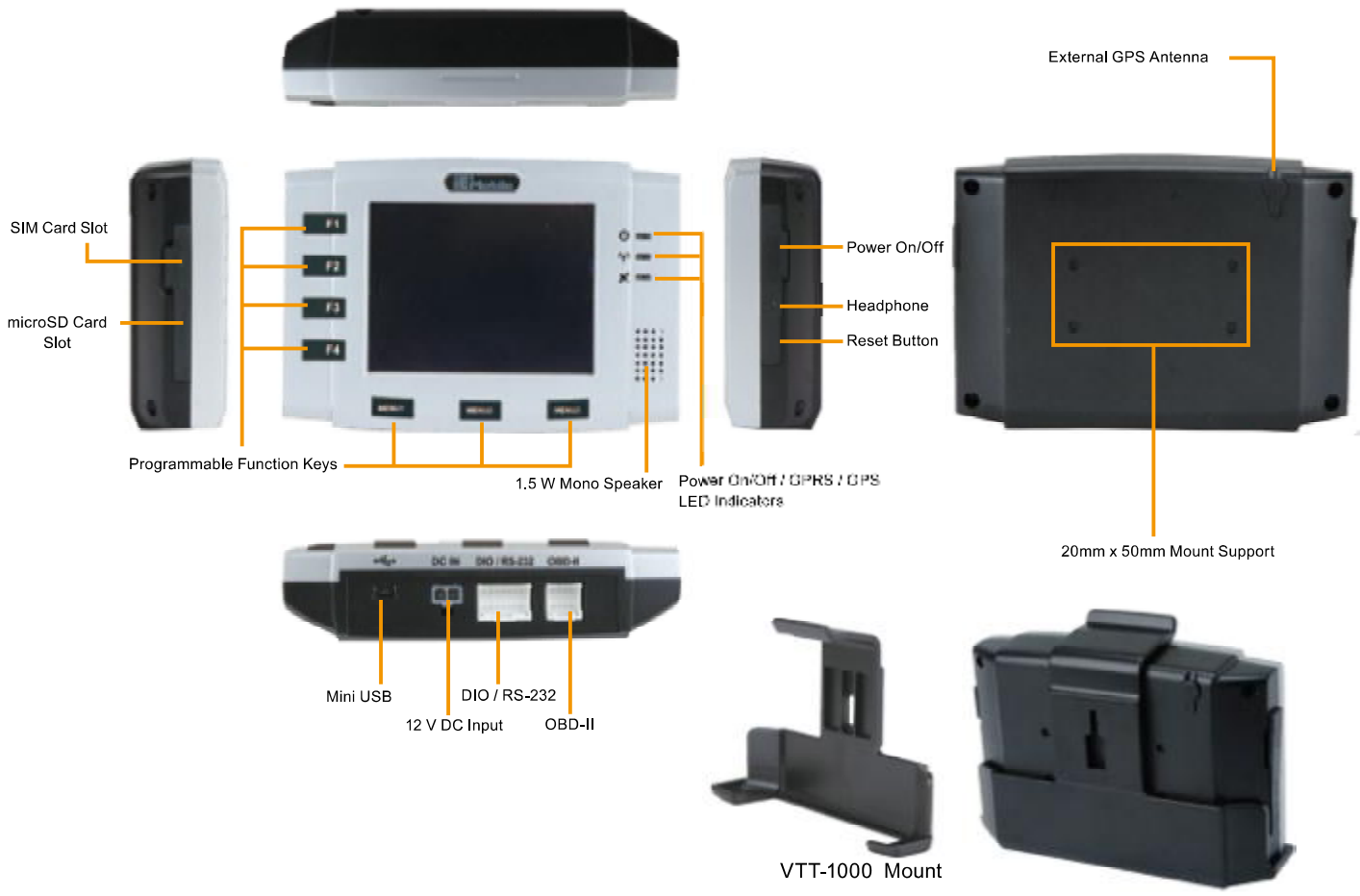

Dimensions (Unit: mm)

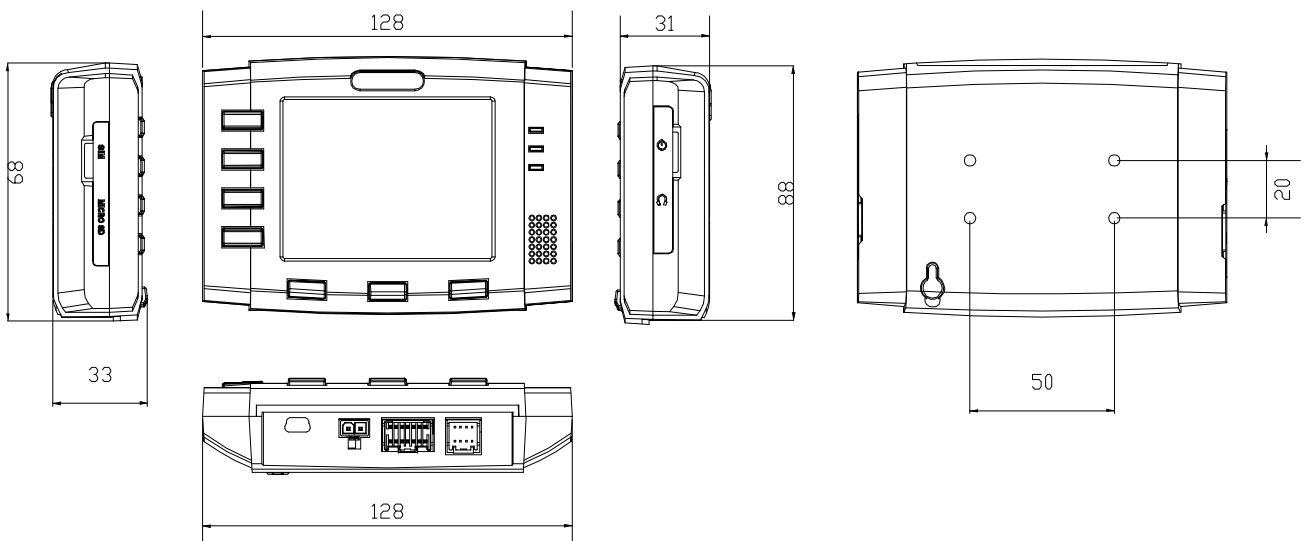

Specifications

Model		VTT-1000	VTT-1000-WiFi
Display	LCD Size	3.5" TFT-LCD	
	Brightness (cd/m ²)	450 cd/m ²	
	Max. Resolution	320 x 240 pixels QVGA	
	Viewing Angle	50/55/60/60 Deg.	
	Touch Screen	4-wire Resistive Type Touch	
System	CPU	Samsung S3C2416 ARM9 400 MHz	
	Operating System	Microsoft® Windows® CE 6.0	
	Memory	128MB DDR2 133MHz On-board	
	Storage	256MB NAND FLASH microSD Card Slot	
Communication	Modem	GSM/GPRS	
	GPS	GPS w/ Internal / External Antenna	
	Wi-Fi	N/A	802.11 b/g
Multimedia	Audio	1 x Line-out, 1 x 1.5W Speaker	
LED Indicators & Buttons	Indicators	Power/GPS/2.5G Status LED	
	Hot Keys	7 x Programm able Keys , Power Button, Reset Button	
I/O Interface	USB	1 x Mini USB 1.1	
	Serial	1 x DB-9 OBD-II, 1 x RS-232	
	Digital I/O	2-bit input, 2-bit output	
Power	Cigarette Lighter Power	DC 9-30V	
Environment	Operating Temperature	-20°C to +70°C	
	Storage Temperature	-30°C to +80°C	
	Humidity	5%~95% Non-Condensing	
	Drop Survival	1M	
	Environmental Protection	IP 54 compliant front panel (water, dust and splash resistant)	
	Certifications	CE/FCC/e-MARK	
Physical Characteristics	Dimensions (LxWxH) (mm)	128 x 89 x 32	
	Net Weight	177g	

Ordering Information

Part Number	Description
VTT-1000-T35A/128MB-00-R10	3.5" 450cd/m ² QVGA Fanless Vehicle Computer with ARM S3C2416X40-Y640 400MHz CPU, 128MB SDRAM, GSM/GPRS, OBD-II, GPS, without AC Adapter, RoHS
VTT-1000-WiFi-R10	3.5" 450cd/m ² QVGA Fanless Vehicle Computer with ARM S3C2416X40-Y640 400MHz CPU, 128MB SDRAM, GSM/GPRS, Wi-Fi, OBD-II, GPS, without AC Adapter, RoHS

Model Variations

Part No.	WiFi	Modem	GPS	OBD-II	CAN BUS 2.0
VTT-1000-T35A/128MB-00-R10	NA	GSM/GPRS	Yes	Yes	NA
VTT-1000-WiFi-R10	Yes	GSM/GPRS	Yes	NA	Yes

Packing List

Item	Part Number	Q'ty
DIO and RS-232 Cable	32016-000300-100-RS	1
OBD-II Cable	32016-000400-100-RS	1
GPS Antenna	32502-000200-100-RS	1
Cigarette Lighter Power Cable	32002-004600-100-RS	1
User's Manual CD-ROM	7B000-000569-RS	1

Optional Accessory List

Item	Part Number	Description
Bracket	VTT-1000-MT01-R10	VTT-1000 Mounting Kit
AC Adapter	IVIPOWER-PIN-R10	Power Adapter 63000-FSP040DGAA1107-RS + Switching Cable 32002-005000-100-RS



GPS Antenna



OBD-II Cable



DIO and RS-232 Integrate Cable



Cigarette Lighter Power Cable



Bracket



AC Adapter