

TANK-860-HM86

- Intel® HM86 mobile solution
- Three different expansion slot options

New

Features

- ◆ Intel® HM86 chipset + 4th generation Intel® Core™ CPU
- ◆ Great flexibility of expansion slots
 - 2-slot model: 2 x PCIe by 16, 1 x PCIe Mini slot
 - 4-slot model: 2 x PCIe by 16, 2 x PCI, 2 x PCIe Mini slot
 - 6-slot model: 1 x PCIe by 16, 2 x PCIe by 4, 3 x PCI, 2 x PCIe Mini slot
- ◆ IPMI function for remote control management
- ◆ Three independent video outputs support high resolution
- ◆ 2 x 2.5" SATA HDD bay design fulfills high storage demand



Automation Solution

The TANK-860 is a fanless expandable embedded system with PCIe and/or PCI slots. With rich I/O, customers can make it as a control center. Furthermore, the ruggedized design make the TANK-860 more reliable even in harsh environments.

- Rich IO
- PCI/PCIe Expansion
- Ruggedized System



- Automation
- Machine Vision
- Data Acquisition

Dual 2.5" SATA HDD/SSD bay

With two 2.5" SATA HDD/SSD bays, users can fulfill large storage requirement and use it as a terminal for data acquisition. The easy to assemble design reduces user fatigue in system installation.

2 x 2.5" SATA 6Gb/s HDD/SSD bay

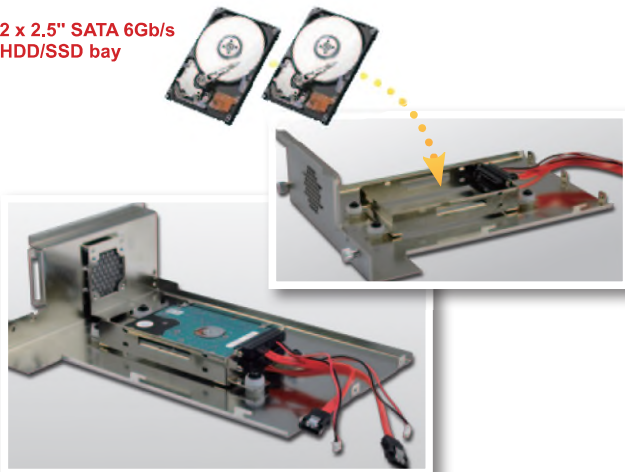

Swappable CFast Design

CFast is based on the Serial ATA bus and supports up to 300 MBps transfer rates, which is much higher than the CF card. With the hot-swappable design, users can replace the CFast even when the system is running.



Abundant Expansion Interface

The TANK-860 series has a great variety of different expansion interfaces. From basic 2-slot expansion model to advanced 6-slot expansion model, customers can choose the most suitable one to apply.

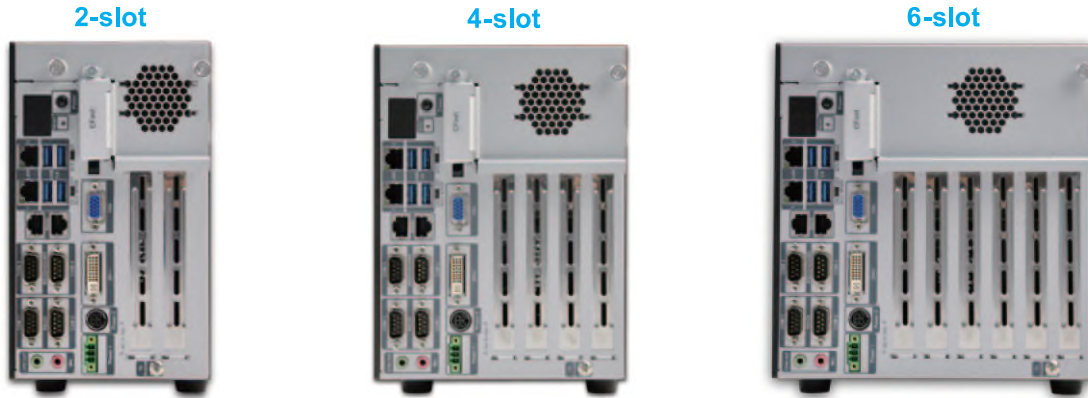

Versatile Expansion Interface

	2-slot model	4-slot model		6-slot model		
Physical Slot	PCIe x16	PCIe x16	PCIe x16	PCIe x16	PCIe x4	PCIe x4
Signal	PCIe x8	PCIe x8	PCIe x8	PCIe x8	PCIe x4	PCIe x4
Slot type	PCIe x16	PCI	PCI	PCI	PCI	PCI
Signal	PCIe x8	PCI	PCI	PCI	PCI	PCI

iRIS Solution



By installing the IEI iRIS-2400 module, the TANK-860 is capable to complete your IoT application through the advanced remote control features, such as power management and control, remote KVM for device status monitoring, sending active alerts and warning messages by e-mail or SMS.

Wide Range Temperature

The TANK-860-HM86 series is designed to withstand wide range of temperatures. With this design, the TANK-860-HM86 series can even be installed in a high-temperature roadside cabinet.



Triple Display

The TANK-860 contains VGA/DisplayPort/DVI video outputs, which can be applied to multi-display application and support high Full HD video quality.



Anti-Vibration and Anti-Shock Design

With the rugged design, the TANK-860-HM86 series is reliable in industrial environments to resist strong vibrations and can be used as a core computer required to be installed on moving objects.



Redundant Dual DC Power Input

The TANK-860-HM86 adopts redundant dual DC power input design, which ensures uninterrupted power supply to the system and eliminates the risk of sudden shutdown and data loss, even if one power is unavailable or low voltage capacity is present.

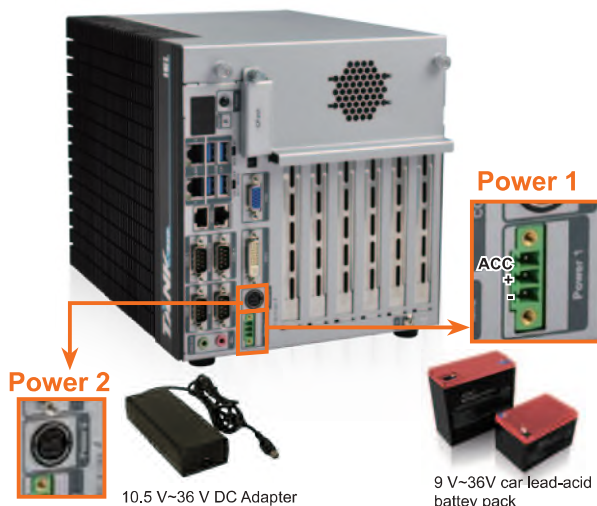

Wide Range DC Power Input

The TANK-860-HM86 series accepts wide range DC power input, allowing it to be powered anywhere, no matter if a 12 V/24 V DC source or a 19 V power adapter is available.



Specifications

Model Name	TANK-860-HM86		
Chassis	Color	Black C + Silver	
	Dimensions (WxHxD) (mm)	2 slot: 121.5 x 255.2 x 205 4 slot: 154.8 x 255.2 x 205 6 slot: 195.4 x 255.2 x 205	
	System Fan	Fanless	
	Chassis Construction	Extruded aluminum alloys	
Motherboard	Processor CPU	Intel® Core™ i5-4400E 2.7 GHz Intel® Celeron® 2000E 2.2 GHz	
	Chipset	Intel® HM86	
	System Memory	2 x 204-pin DDR3 SO-DIMM 4 GB pre-installed (system max: 16 GB)	
IPMI	iRIS Solution	iRIS-2400	
Storage	Hard Drive	2 x 2.5" SATA 6Gb/s HDD/SSD bay	
	CF Card/CFast	1 x CFast	
	mSATA	1 x mSATA (SATA 3Gb/s signal)	
I/O Interfaces	USB 3.0	4	
	USB 2.0	2	
	Ethernet	2 x RJ-45 1 x PCIe GbE by Intel® I210 1 x PCIe GbE by Intel® I217LM	
	RS-232	4 x DB-9 (two with isolation)	
	RS-422/485	2 x RJ-45	
	Digital I/O	8-bit digital I/O, 4-bit input/4-bit output	
	Display	1 x VGA, 1 x DVI-I, 1 x DisplayPort	
	Resolution	VGA: Up to 1920 x 1200@60Hz DVI-I: Up to 2500 x 1600@60Hz Displayport: Up to 2500 x 1600@60Hz	
	Audio	1 x Line-out, 1 x Mic-in	
	Wireless	802.11b/g/n 1T1R (optional)	
	Expansions	PCI/PCIe	2A: Two PCIe x8 (physical PCIe x16 slot) 4A: Two PCIe x8 (physical PCIe x16 slot) + 2 x PCI 6A: One PCIe x8 (physical PCIe x16 slot) + 2 x PCIe by 4 + 3 x PCI
		PCIe Mini	2A: 1 x Full-size (Co-lay mSATA) 4A: 1 x Full-size (Co-lay mSATA) + 1 x Full-size (on backplane) 6A: 1 x Full-size (Co-lay mSATA) + 1 x Full-size (on backplane)
Power	Power Input	DC Jack: 9 V~36 V DC	
	Power Consumption	19 V@3.34 A (Intel® Core™ i5-4400E with 4 GB memory)	
Reliability	Mounting	Wall mount	
	Operating Temperature	-20°C ~ 70°C with air flow (SSD), 5% ~ 95%, non-condensing	
	Operating Shock	Half-sine wave shock 5G, 11ms, 3 shocks per axis	
	Operating Vibration	MIL-STD-810F 514.5C-2 (with SSD)	
	Weight (Net/Gross)	2-slot: 4.2 kg/6.3 kg 4-slot: 4.5 kg/6.5 kg 6-slot: 4.8 kg/6.9 kg	
	Safety/EMC	CE/FCC	
OS	Supported OS	Microsoft® Windows® 8 Embedded, Microsoft® Windows® Embedded Standard 7 E	

Dimensions (Unit: mm)

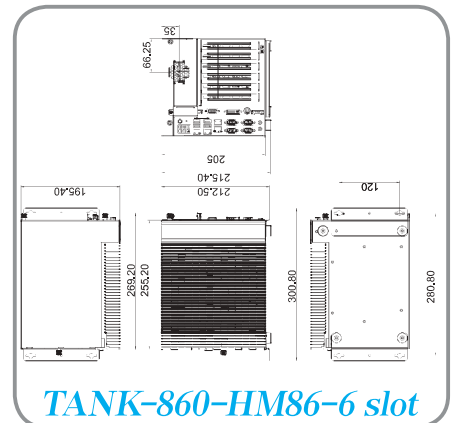
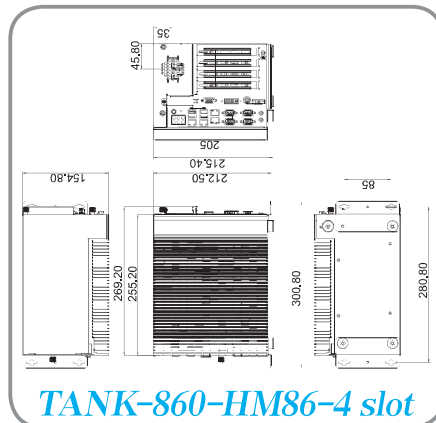
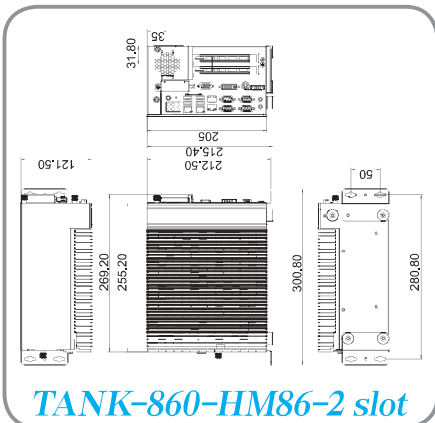

Fully Integrated I/O

Front View



- Power switch
- 1. Long-press 2 sec. to power on
- 2. Long-press 5 sec. to power off
- DisplayPort
- DIO
- 2 x USB 2.0

Rear View

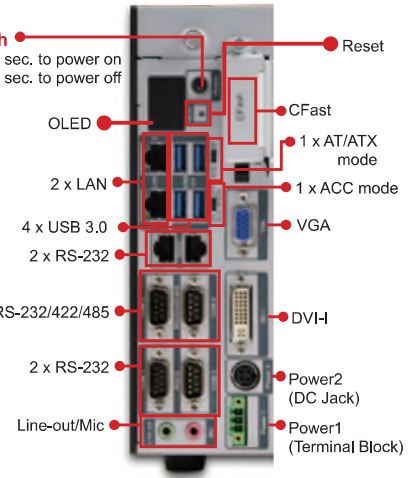

- Reset
- CFast
- 1 x AT/ATX mode
- 1 x ACC mode
- VGA
- 2 x LAN
- 4 x USB 3.0
- 2 x RS-232
- 2 x RS-232/422/485
- 2 x RS-232
- Line-out/Mic
- DVI-I
- Power2 (DC Jack)
- Power1 (Terminal Block)

Ordering information

Part No.	Description
TANK-860-HM86i-i5/4G/2A-R10	Intel® Core™ i5-4400E 2.7 GHz dual-core, TDP 37W, 4GB DDR3 pre-installed memory, 2 x PCIe expansion, VGA/DVI/DisplayPort, iRIS-2400 optional, 9 V~36 V DC, R10, RoHS
TANK-860-HM86i-i5/4G/4A-R10	Intel® Core™ i5-4400E 2.7 GHz dual-core, TDP 37W, 4GB DDR3 pre-installed memory, 2 x PCIe and 2 x PCI expansion, VGA/DVI/DisplayPort, iRIS-2400 optional, 9 V~36 V DC, R10, RoHS
TANK-860-HM86i-i5/4G/6A-R10	Intel® Core™ i5-4400E 2.7 GHz dual-core, TDP 37W, 4GB DDR3 pre-installed memory, 3 x PCIe and 3 x PCI expansion, VGA/DVI/DisplayPort, iRIS-2400 optional, 9 V~36 V DC, R10, RoHS
TANK-860-HM86i-C/4G/2A-R10	Intel® Celeron® 2000E 2.2 GHz dual-core, TDP 37W, 4GB DDR3 pre-installed memory, 2 x PCIe expansion, VGA/DVI/DisplayPort, iRIS-2400 optional, 9 V~36 V DC, R10, RoHS
TANK-860-HM86i-C/4G/4A-R10	Intel® Celeron® 2000E 2.2 GHz dual-core, TDP 37W, 4GB DDR3 pre-installed memory, 2 x PCIe and 2 x PCI expansion, VGA/DVI/DisplayPort, iRIS-2400 optional, 9 V~36 V DC, R10, RoHS
TANK-860-HM86i-C/4G/6A-R10	Intel® Celeron® 2000E 2.2 GHz dual-core, TDP 37W, 4GB DDR3 pre-installed memory, 3 x PCIe and 3 x PCI expansion, VGA/DVI/DisplayPort, iRIS-2400 optional, 9 V~36 V DC, R10, RoHS

Options

Item	Part No.	Description
OS: Windows Embedded 7 (CD-ROM)	TANK-860-HM86-WES7E-R10 (CD-ROM)	OS Image with Windows® Embedded Standard 7 E for TANK-860 H Series, with CD-ROM, RoHS
Power cord	32702-000401-100-RS	Power cord
Power adapter	63040-010090-050-RS	Vin: 90~264VAC; 90W, Vout: 19VDC; Din 4Pin/lock; meet PSE & ERP
	63040-010150-000-RS	Vin: 90~264VAC; 150W, Vout: 19VDC; Din 4Pin/lock; meet PSE & ERP

* 90W adapter is suggested for no add-on cards applications. For add-on cards applications, please choose adapter based on power consumption of TANK-860 (65W) + add-on card power consumption.

Packing list

1 x Utility CD	1 x Chassis Screw
1 x One Key Recovery CD	1 x Mounting Bracket