

SATA to CFast™ Converter Board

New

SACFA-KIT01-R10

SATA to CFast™ converter board

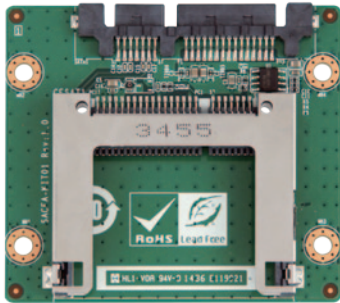

32801-000100-300-RS

Dimensions (Unit: mm)

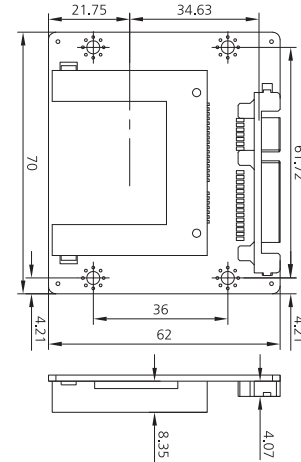

Features

1. CFast™ socket
2. 7-pin SATA data connector, and a female 17-pin power CFast™ connector

Packing List

- 1 x SACFA-KIT01-R10
- 1 x QIG

Ordering Information

Part No.	Description
SACFA-KIT01-R10	SATA to 24-pin CFast™ socket converter board
32801-000100-100-RS	SATA 7+15P female to SATA 7P / PH 2.5 4P cable, L=200mm/200mm
32801-000201-100-RS	SATA 7+15P female to SATA 7P / PH 2.0 2P cable, L=150mm/150mm
32000-080700-RS	SATA 7+15P female to SATA 7P / PH 5.08 4P cable, L=200mm/100mm

SATA to CF Type II Converter Board

SACF-KIT01-R10

SATA to CF converter board



32801-000100-300-RS

Dimensions (Unit: mm)

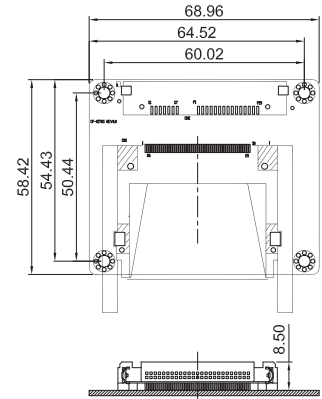

Features

1. CF Type II socket
2. 50-pin CF Type II connector

Packing List

- 1 x SACF-KIT01-R10
- 1 x QIG
- 1 x SATA with power cable kit (P/N: 32801-000100-300-RS)

Ordering Information

Part No.	Description
SACF-KIT01-R10	SATA to 50-pin CF socket converter board
45015-002858-00-RS	CF Type II cover with right side ejector

SATA to IDE/CF Type II Converter Board

SAIDE-KIT01-R10

SATA to IDE/CF converter board

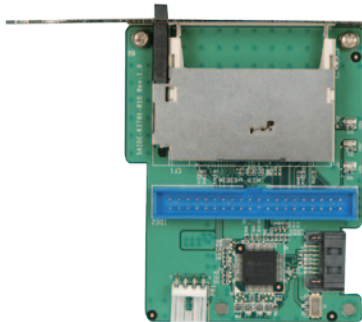

32100-064401-RS

Dimensions (Unit: mm)

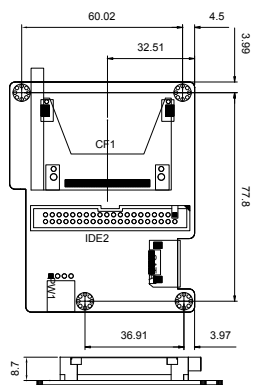

Features

1. CF Type II socket
2. 40-pin IDE connector (master mode)
3. 4-pin 5V input connector
4. Power/5V/HDD LED indicator
5. Support one IDE device or one CF

Packing List

- 1 x SAIDE-KIT01-R10
- 1 x QIG
- 1 x Power cable (P/N: 32100-171800-RS)

Ordering Information

Part No.	Description
SAIDE-KIT01-R10	SATA to 40-pin IDE/CF socket converter board with bracket
32000-062800-RS	SATA cable
32102-000100-200-RS	SATA power cable
32100-064401-RS	Power cable

IDE/CF Type II Converter Board

CF-KIT04-R10 IDE to CF Type II converter board with master/slave mode selection

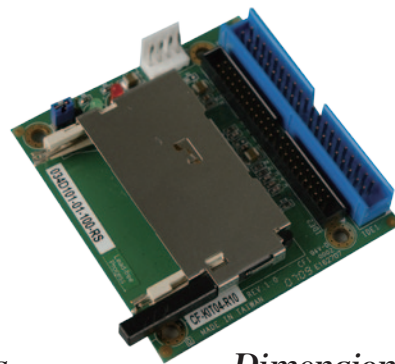

Features

1. CF Type II socket with master/slave mode selection
2. 4-pin power connector
3. Power/HDD signal LED

Dimensions (Unit: mm)

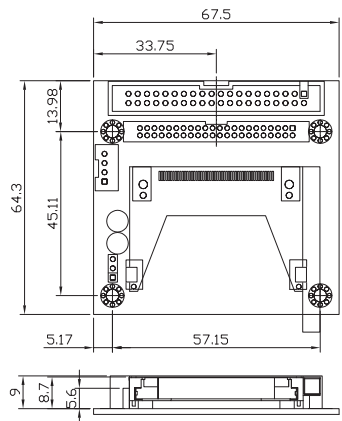

IEI CF Solution



iCF1000 Industrial standard grade



iCF1000 Wide Temp. grade